



Base model pictured.
Technical details subject to change without notice.
Various engine and pump material construction options
available on request.

Technical DATA Sheet

The **Heli-Flo** pump range has been specifically designed and engineered to work in the highly abrasive and corrosive applications associated with high pressure mine dewatering.

Specific emphasis has been placed on using correct materials of construction and coating to ensure we have achieved the lowest possible operating costs. Used extensively by major mining companies and dewatering contractors, they continue to out-perform others every time.

Join the ever-growing list of mining companies finding the Heli-Flo pump “the best pumps we have on site”.

FREECALL: 1800 813 677
www.truflopumps.com.au

8-14 Irving Place, Bathurst NSW 2795

HELI-FLO TF084

FEATURES

- ▶ Highest efficiencies
- ▶ Abrasive handling
- ▶ Optimum reliability
- ▶ Variable speeds available
- ▶ Simple maintenance
- ▶ Easy installation
- ▶ Energy efficient
- ▶ Easy servicing
- ▶ Robust construction
- ▶ Ideal for slurry pumping

APPLICATIONS

- ▶ Highlift underground mine dewatering
- ▶ Decline development pumping
- ▶ Mobile contractor pumps
- ▶ Permanent dewatering pumping stations
- ▶ Mineral processing

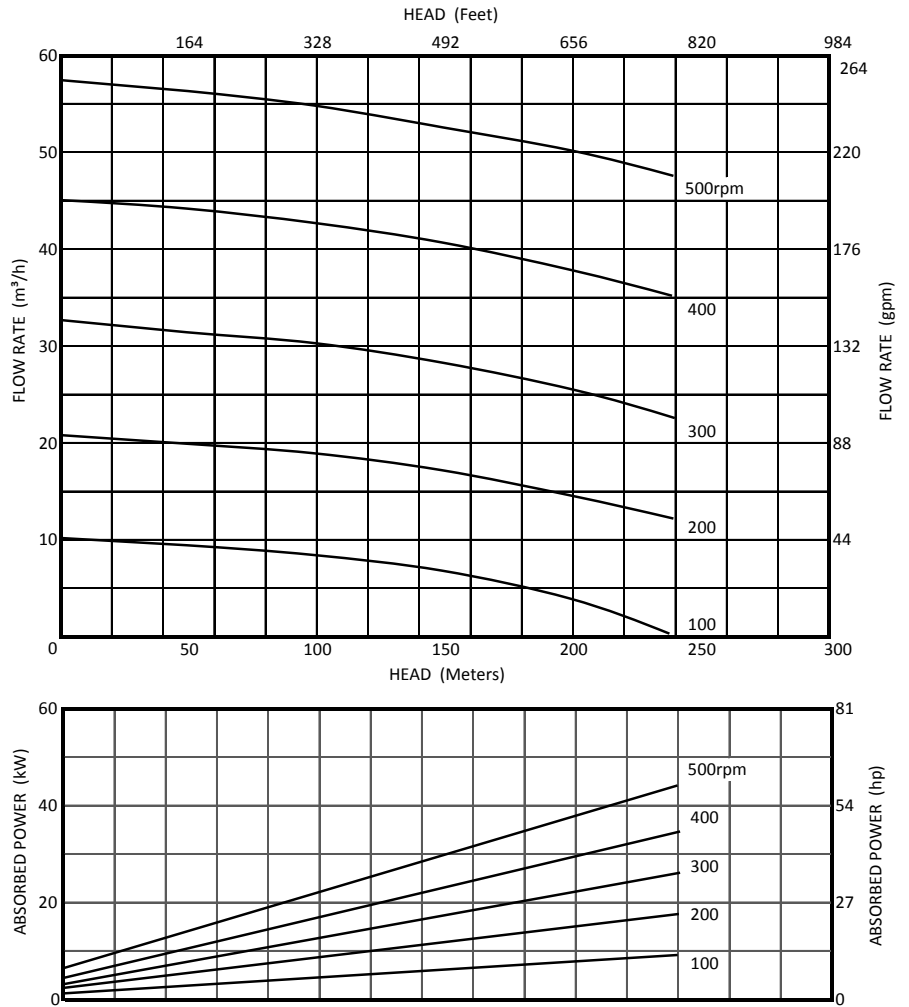

Tested on water at 20°C (68°F)

PUMP CONSTRUCTION

Inlet Casing:	Cast Iron
Rotor:	Stainless Steel, Hard Chrome Plated
Stator:	Natural Rubber
Flexishaft:	420 Stainless Steel Epoxy Coated
Skid Frame:	Galvanised Structural Mild Steel

MOTOR DETAILS

Model:	Premium Efficiency Mining Motor
Motor Size:	45kW (60hp)
Motor Speed:	990rpm (6 Pole)
Motor Voltage:	1000V

DESIGN DETAILS

Maximum Operating Speed:	500 rpm
Head:	240m (24 Bar)
Maximum Flow:	14L/sec (222gpm)
Inlet Diameter:	150mm (6")
Outlet Diameter:	150mm (6")
Minimum Starting Torque:	730N.m
Hopper Tank:	5400L (1426 US gal)
Base Footprint:	4420 x 1400mm (174 x 55")
Dry Weight:	3500kg (1700lb)

Other voltage options available on request.

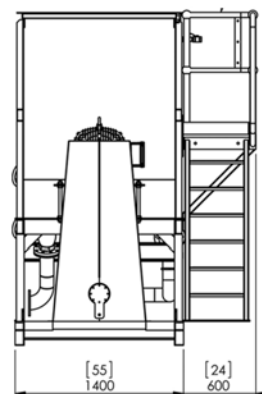
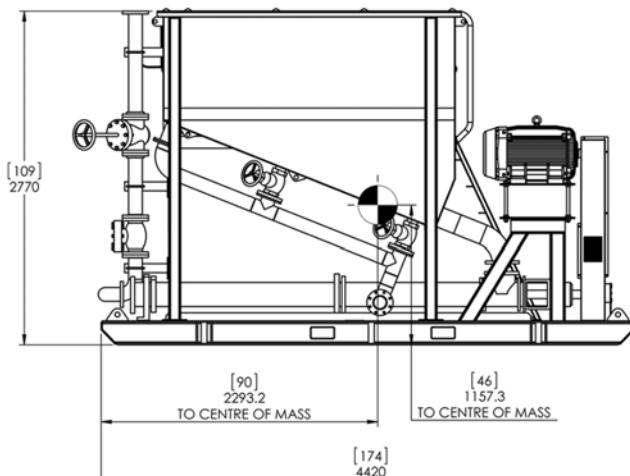

Technical details subject to change without notice.

Various engine and pump material construction options available on request.