

TF140-100 Datasheet Vac-assisted dewatering pumpsets

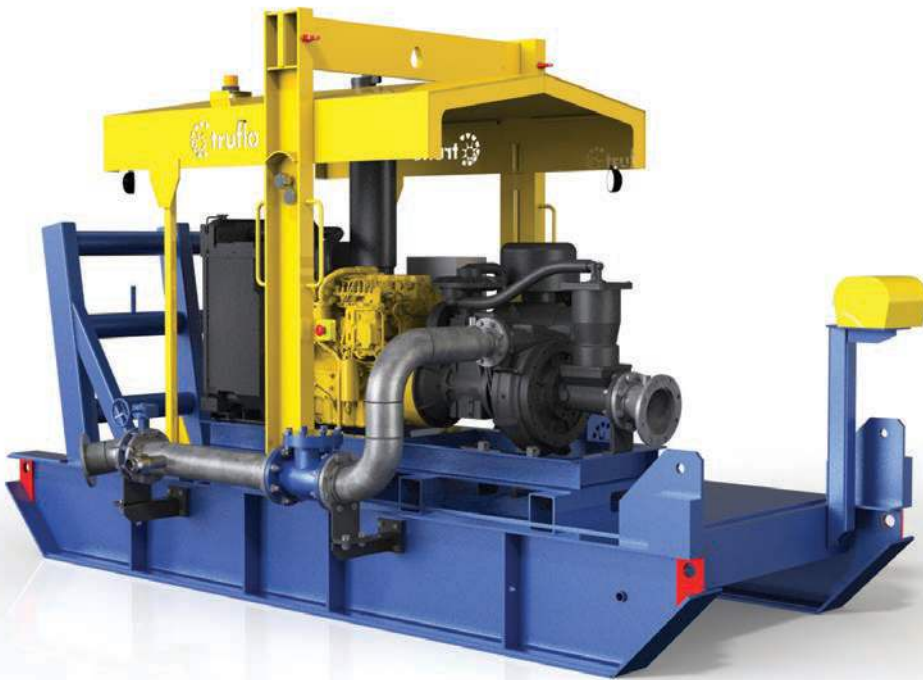

Standard Pumpset Features

- Australian-made and Australian-owned
- Electronic pump control and alert system
- Superior solids handling capabilities
- Operates in snore conditions
- Standard pumpsets configurable to suit inlet and outlet positioning
- Vac-assisted self-priming
- Robust engine canopy with central lift point
- Inbuilt extreme duty positioning "push bar" on skid configuration
- 24-hour runtime (dependent on final engine choice and pumpset duty)
- Ease of maintenance
- Full set of industry standard safety and operational signage applied to equipment
- Comprehensive installation, operations and spare parts manual linked to machine serial number
- OEM parts supplier for all the pumpset range
- Superior nation-wide customer service and support linked to equipment serial number.

Standard Supply Offerings

Truflo PumpMaster Control

- Full engine protection
- Full pump protection
- Suction and pressure transducers
- Loss of flow switch
- Pump temperature protection
- Remote Start ready
- Telemetry ready

Built to Australian standards and robust mining industry expectations

50cfm vacuum diaphragm pump

Powered by Caterpillar or Cummins engines

Truflo Mining Series Wet-end with high grade duplex impeller

Marine grade 2-pack paint

Baffled fuel tank base

Bisalloy replaceable wear plates

Fitted non-return valve on pump discharge

Isolation valve

Purpose built exhaust system heat shielding

OEM genuine wiring harness

Battery and Start Isolation

Vented steel battery box

350 amp jump start receptacle

Mechanical fuel gauge

External Emergency Stop button

Depressurised radiator cap

50mm Splash Fill fuel inlet

Engine, oil and coolant drain

Standard pumpset configuration customisable on request.

Truflo Pumps' Vac-assisted Dewatering Pumpsets have established an enviable reputation as the market leader in the design, development and manufacture of high performing dewatering and water transfer equipment. Our pumpsets are developed on the premise of providing the very best in dependability, efficiencies, and value for money.



This equipment is used extensively throughout the mining, quarrying and other heavy duty industries together with major rental and dewatering contractors — Truflo Pumps are renowned for their solids handling capacity and outstanding operation efficiencies.

A major strength is that Truflo Pumps manufactures their own pump parts right here in Australia, directly controlling the exacting quality and OEM parts supply that customer's have come to expect. We work with you to build pumps to suit your specific application or challenge.

B Series

TF140-100 DATASHEET

Standard Options

- Suction a-frame jib & winch
- Wiggins style engine lube / coolant drain
- Wiggins style low pressure fast fuel fill
- Drag chains
- LED work lights
- Amber strobe light (LED)
- Secondary Emergency Stop
- Fire extinguisher
- Heavy duty suction hose
- Suction inlet strainer
- Titan high clearance skid
- Dual discharge
- Solar panel and trickle charger
- Boost pump ready
- Flowmeter
- Auxillary fuel inlet
- Full duplex wet-end
- Full stainless steel suction and discharge manifold
- Telemetry systems
- Auto start/stop systems
- Bunded fuel tank base

Alternate Configurations

- Pontoon mounted
- Trailer mounted
- Sound attenuated.

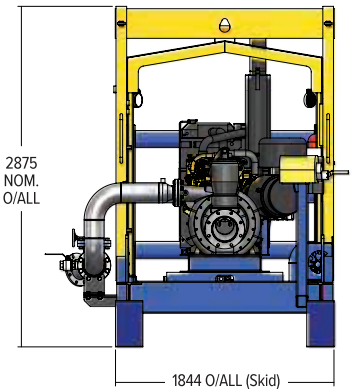
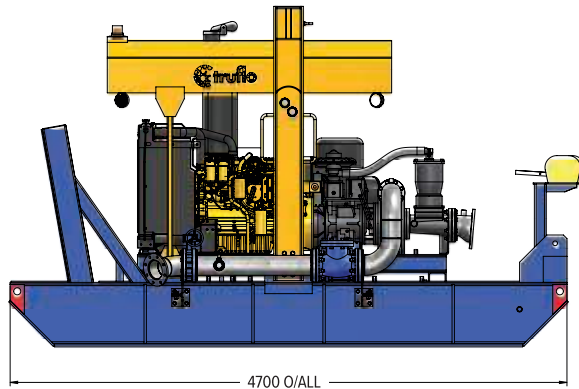
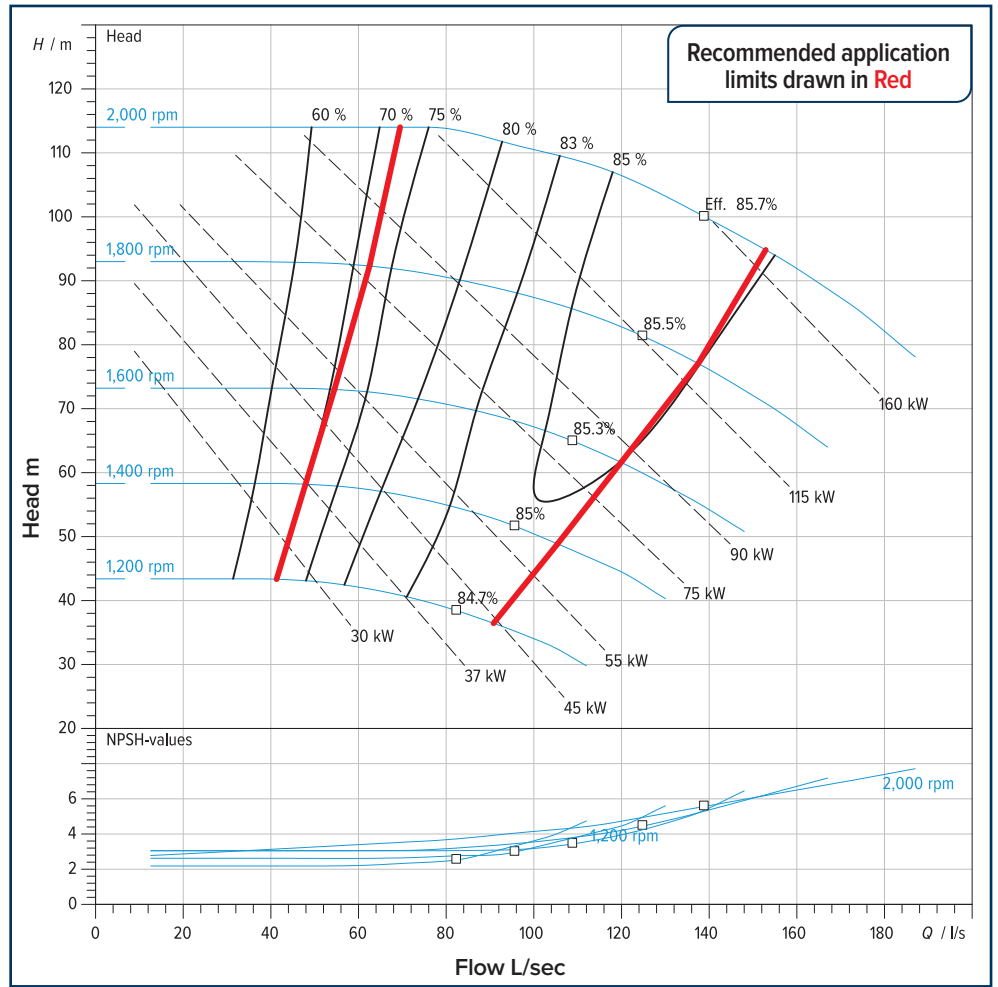

PUMP SPECIFICATIONS

Suction	200mm ANSI Flanged
Discharge	125mm ANSI Flanged
Impeller Design	416mm Enclosed
Solids Handling	19mm
Coupling	Flywheel, SAE direct flanged
Max Operating Temp	100°C
Operating Speed	Min 1200 rpm Max 2000 rpm

PUMP PERFORMANCE

Qmax	180 L/sec
Hmax	110m

PUMP PRIMING SYSTEM

Vacuum Pump Type	Diaphragm
Nominal Air Capacity	50 cfm
Max Vacuum	0.9 bar
Drives	Belt

PUMP CONSTRUCTION

Pump Casing	Ductile Cast Iron <i>with option of</i> CD4MCu Duplex Stainless Steel
Impeller	CD4MCu Duplex Stainless Steel
Wear Plate / Ring	Nitronic 60 Stainless Steel
Suction Cover and Backplate	Ductile Cast Iron <i>with option of</i> CD4MCu Duplex Stainless Steel
Shaft	316 Stainless Steel
Mechanical Seal	Silicon Carbide / Tungsten Carbide
Bearings	Angular Contact / Deep Groove

CONSTRUCTION SPECIFICATIONS

Base Type	B Series
Dry Weight*	5600kg
Fuel Capacity	1500 Litres
Suction Manifold	200mm Flanged HD Gal
Discharge Manifold	150mm Flanged HD Gal
Nominal Dimension	4700 x 1844 x 2875mm

RECOMMENDED ENGINE

Cummins Model	QSB6.7
Caterpillar Model	C7.1 ACERT

*Guide only, all subject to final pumpset configuration. Technical details subject to change without notice, more detailed engine and pump material construction options available on request.